



① x 4

② x 2

③ x 1

④ x 2

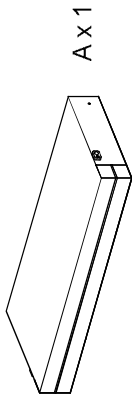
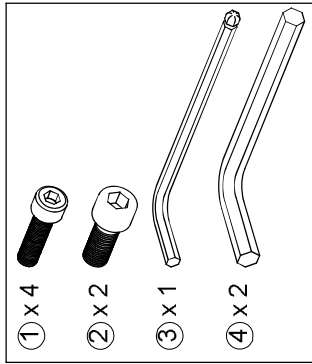

AX 1

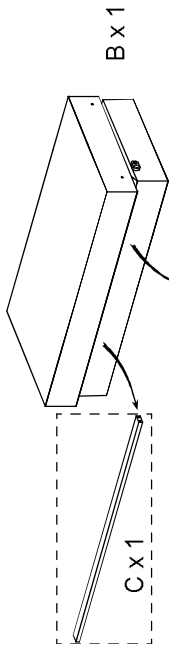

BX 1

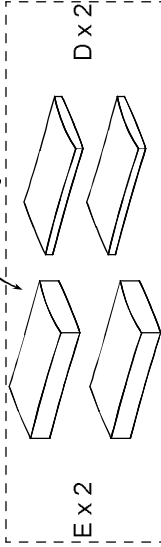

EX 2

DX 2

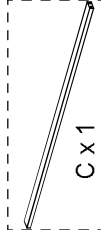

CX 1

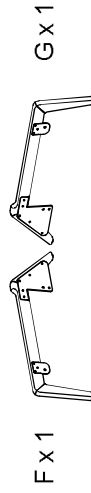

FX 1



GX 1



HX 2



JX 6



KX 6

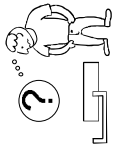

www.innovationliving.com

069815

1

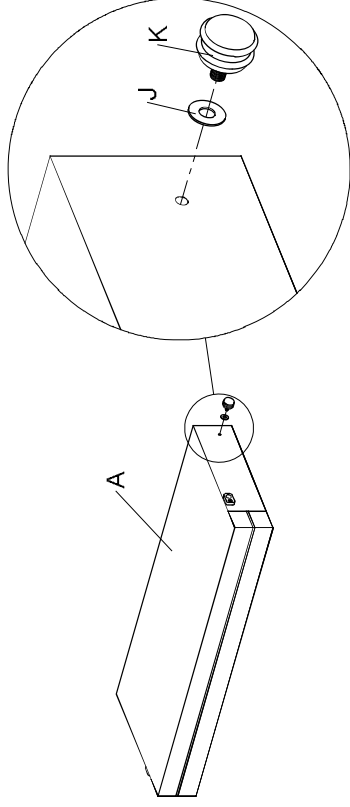

2

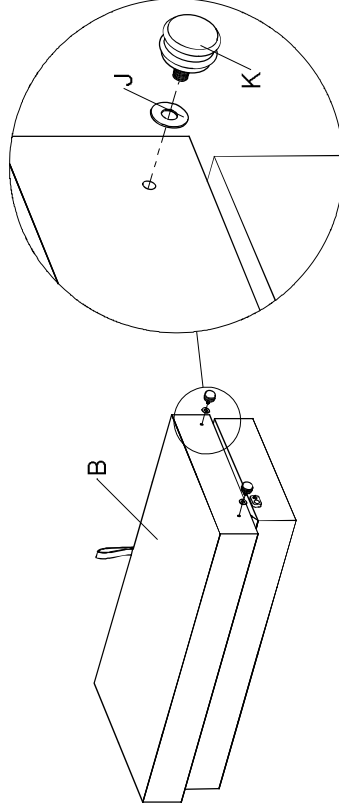

3

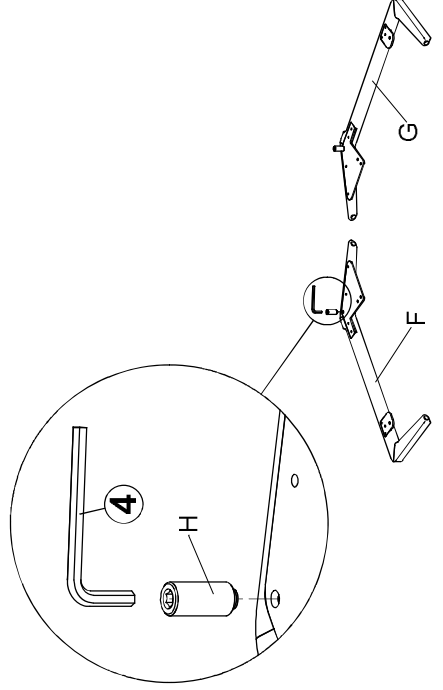

Betræk til puderne vil du finde, når du åbner lynlåsen under sædet.  
 The cover for the cushions you will find, when you open the zipper under the seat.  
 Den Kissenbezug finden Sie indem Sie den Reißverschluss unter dem Sitz öffnen.  
 Vous trouverez la housse pour les coussins en ouvrant la fermeture sous le siège.  
 De hoes voor de kussens vindt u onder het zitgedeelte na het openen van de rits.  
 靠枕外套放在坐垫里面，取出时请拉开坐垫底部拉链。  
 Чехлы для подушек Вы найдете под сиденьем дивана, расстегнув «молнию».

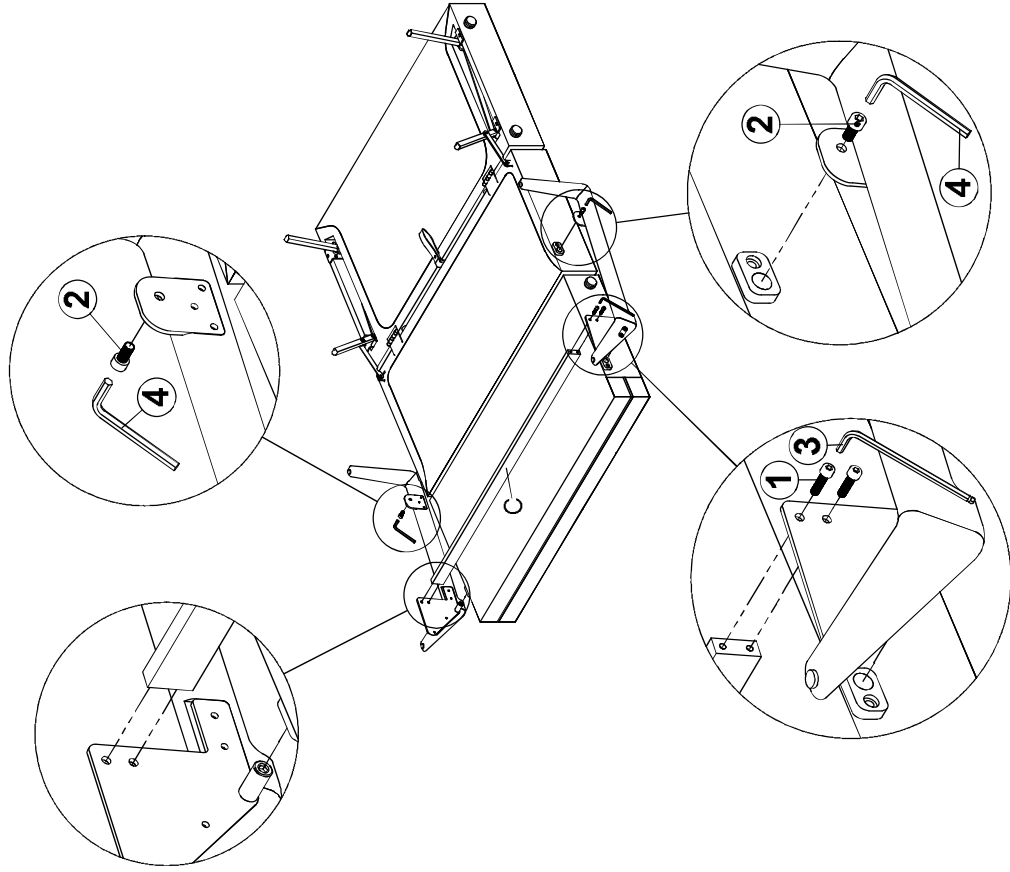

1

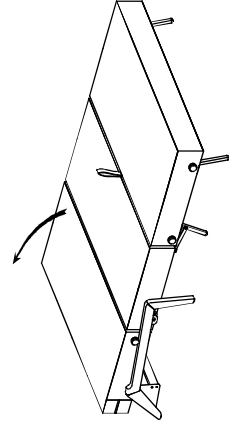

2

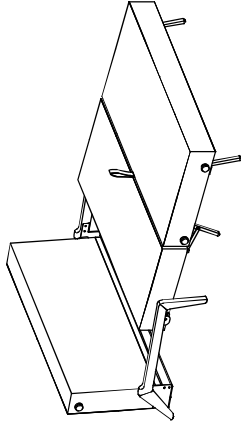

SOVE-SCHLAFEN-SLEEP-DORMIR

3

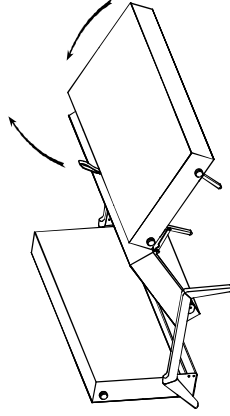

4

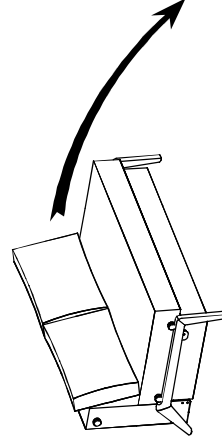
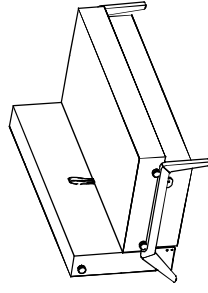

SIDDE-SITZEN-SIT-ASSISE

